

Mesa de Jantar / Dinner table / Mesa de Cenar

MH-9145

Montagem

Recomenda-se a leitura prévia das instruções de montagem e profissionais especializados para montar.

Assistência

Caso ocorra problema com algum dos componentes, sublinhe-o, identifique o problema e retorne esta relação, via fax ou meio de comunicação disponível para o representante.

 Assinatura do cliente

Assembly

Before the assembling is recommended to read carefully the assembly instruction by professional assemblers.

Assistance

If happen problems with any component, underline the same, identify the problem and send back this relation immediately, by fax or other way.

 Client signature

Montaje

Se recomienda la lectura previa de las instrucciones de montaje y profesionales especializados para montarlos.

Asistencia

Caso sucedan problemas con alguno de los componentes, subraye el componente, identifique el problema, y retorne esta copia via fax u otro medio de comunicación posible.

 Assinatura del cliente

2800x1200MM
3000x1200MM
3200x1200MM

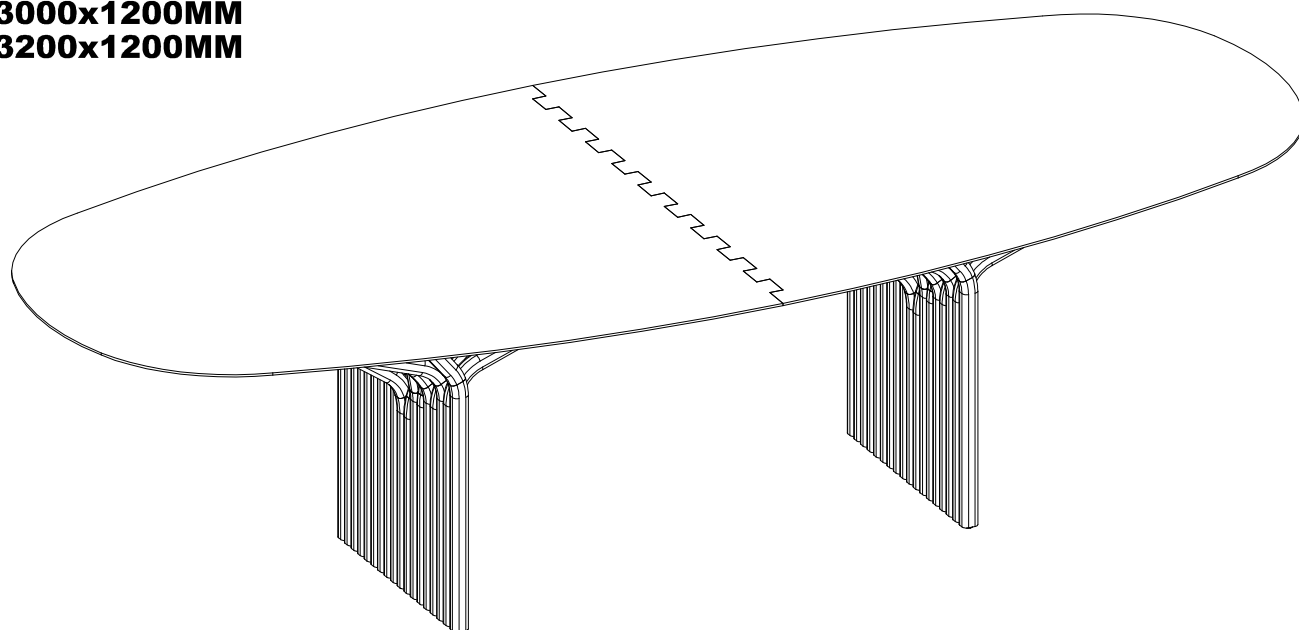

Atenção / Attention / Atención

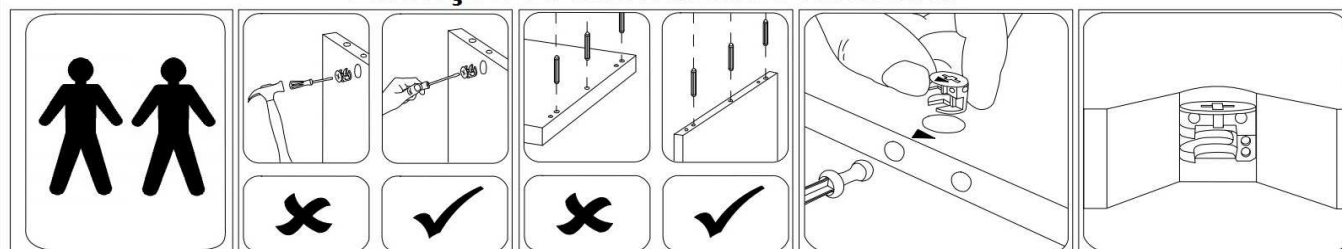

A Uultis se reserva o direito de efetuar alterações nos produtos de suas linhas sem aviso prévio, quando entender necessário.

Uultis reserves the right to effect modifications in the products, without previous advice, when understand necessary.

Uultis se reserva el derecho de hacer las modificaciones que juzgue necesarias en sus productos, sin aviso previo, cuando lo crea necesario.

Assistência Uultis
(51) 3564-8382

MH-9145

RELAÇÃO DE COMPONENTES / PARTS LIST / LISTA DE COMPONENTES

VOLUME 1

LETRA	LÂMINADO	PEÇA	PART	PIEZA	MED/MEASURE/MED	QTDE
-	K071995	KIT ACESSÓRIOS 2	ACCESSORY KIT 2	KIT DE ACCESORIOS 2	xx	1
A	EM91459	PÉ PRÉ MONTADO	PRE-ASSEMBLED FOOT	PIE PREMONTADO	xx	1

VOLUME 2

LETRA	LÂMINADO	PEÇA	PART	PIEZA	MED/MEASURE/MED	QTDE
-	K071995	KIT ACESSÓRIOS 2	ACCESSORY KIT 2	KIT DE ACCESORIOS 2	xx	1
A	EM91459	PÉ PRÉ MONTADO	PRE-ASSEMBLED FOOT	PIE PREMONTADO	xx	1

VOLUME 3

LETRA	CANTO ECLIPSE	CANTO OBLONGO	CANTO REDONDO	CANTO RETO	LACA	LÂMINADO	PEÇA	PART	PIEZA	MED/MEASURE/MED	QTDE
-	K071994	K071994	K071994	K071994	K071994	K071994	KIT ACESSÓRIOS 1	ACCESSORY KIT 1	KIT DE ACCESORIOS 1	xx	1
B	131175E	131175E	131175E	131175E	131175K	131175E	SUPORTE UNIAO	UNION SUPPORT	SOPORTE UNIÓN	550.0x200.0x25.0	1
E	6175240	6146921	6104694	6104694	131169K	131169E	TAMPO ESQ	LEFT TOP	TAMPO IZQUIERDO	1415.0x1200.0x25.0	1
F	6175350	6146922	9104695	9104695	131170K	131170E	TAMPO DIR	RIGHT TOP	TAMPO DERECHO	1415.0x1200.0x25.0	1

VOLUME 3

LETRA	CANTO ECLIPSE	CANTO OBLONGO	CANTO REDONDO	CANTO RETO	LACA	LÂMINADO	PEÇA	PART	PIEZA	MED/MEASURE/MED	QTDE
-	K071994	K071994	K071994	K071994	K071994	K071994	KIT ACESSÓRIOS 1	ACCESSORY KIT 1	KIT DE ACCESORIOS 1	xx	1
B	131175E	131175E	131175E	131175E	131175K	131175E	SUPORTE UNIAO	UNION SUPPORT	SOPORTE UNIÓN	550.0x200.0x25.0	1
I	6175486	6146926	6104570	6104570	131171K	131171E	TAMPO ESQ	LEFT TOP	TAMPO IZQUIERDO	1515.0x1200.0x25.0	1
J	6175518	6146927	6104571	6104571	131172K	131172E	TAMPO DIR	RIGHT TOP	TAMPO DERECHO	1515.0x1200.0x25.0	1

VOLUME 3

LETRA	CANTO ECLIPSE	CANTO OBLONGO	CANTO REDONDO	CANTO RETO	LACA	LÂMINADO	PEÇA	PART	PIEZA	MED/MEASURE/MED	QTDE
-	K071994	K071994	K071994	K071994	K071994	K071994	KIT ACESSÓRIOS 1	ACCESSORY KIT 1	KIT DE ACCESORIOS 1	xx	1
B	131175E	131175E	131175E	131175E	131175K	131175E	SUPORTE UNIAO	UNION SUPPORT	SOPORTE UNIÓN	550.0x200.0x25.0	1
M	6173835	6146940	6104716	6104716	131173K	131173E	TAMPO ESQ	LEFT TOP	TAMPO IZQUIERDO	1615.0x1200.0x25.0	1
N	6173834	6146950	6104718	6104718	131174K	131174E	TAMPO DIR	RIGHT TOP	TAMPO DERECHO	1615.0x1200.0x25.0	1

VOLUME 4

LETRA	LÂMINADO	PEÇA	PART	PIEZA	MED/MEASURE/MED	QTDE
C	F9103180	CANTONEIRA 1500MM	IRON BAR	BARRA DE HIERRO	1500x31.75x31.75	2

VOLUME 4

LETRA	LÂMINADO	PEÇA	PART	PIEZA	MED/MEASURE/MED	QTDE
D	127314E	CANTONEIRA 1600MM	IRON BAR	BARRA DE HIERRO	1600x31.75x31.75	2

VOLUME 4

LETRA	LÂMINADO	PEÇA	PART	PIEZA	MED/MEASURE/MED	QTDE
G	129889E	CANTONEIRA 1700MM	IRON BAR	BARRA DE HIERRO	1700x31.75x31.75	2

**Canto Oblongo
Oblong Corner
Esquina Oblongada**

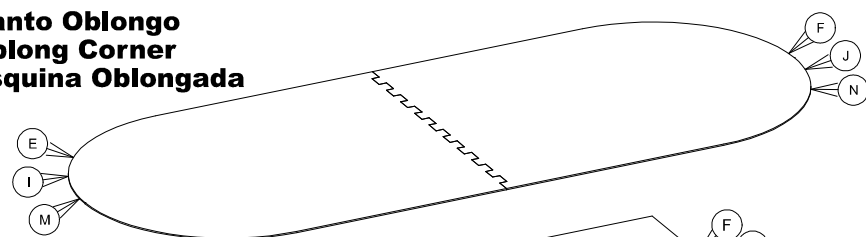

**Canto Reto
Square Corner
Esquina Recto**

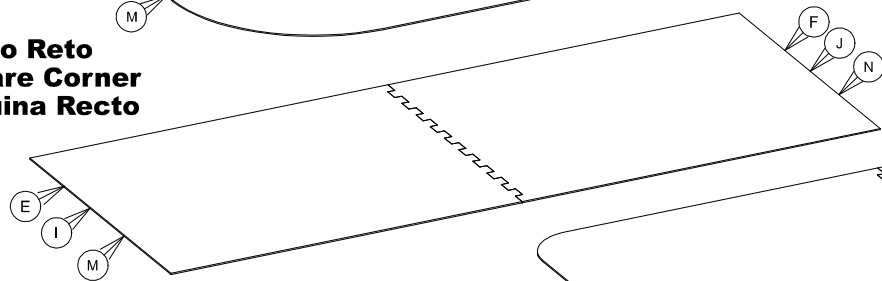

**Canto Redondo
Round Corner
Esquina Redonda**

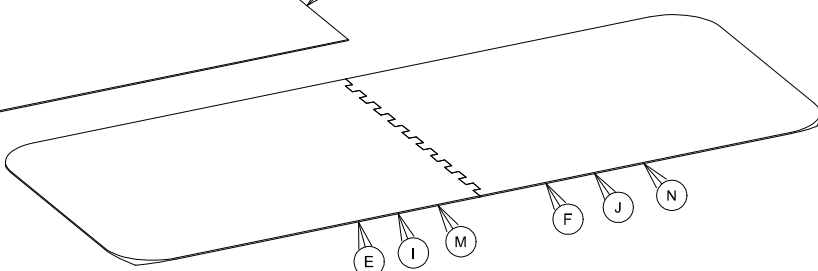

**Canto Eclipse
Sing Eclipse
Canto Eclipse**

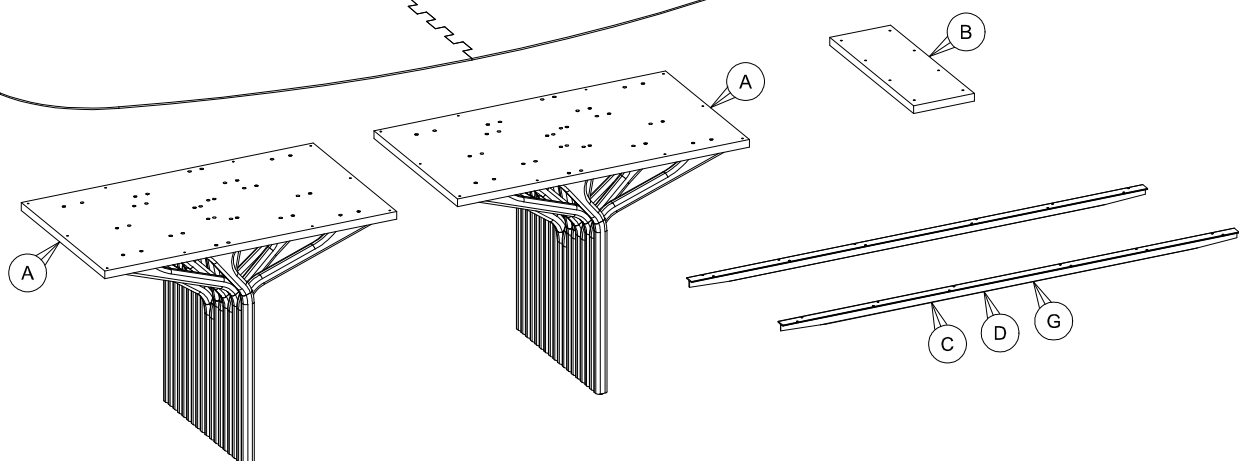
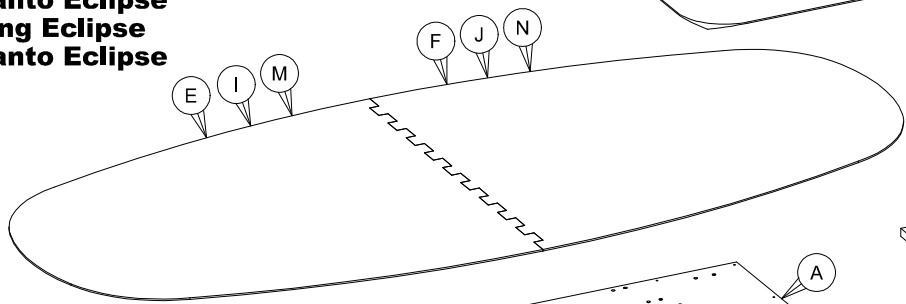





MH-9145

RELAÇÃO DE COMPONENTES / PARTS LIST / LISTA DE COMPONENTES

CÓDIGO DO KIT: **K071994**



KIT 1

REF.	QTDE	PEÇA	PART	PIEZA	IMAGE
1.s	2	CHAVE DE BOCA RETA 13 ABERT.	KEY	CLAVE	
12.a	2	CAVILHA MADEIRA 10X60	10X60 WODEN PLUG	TARUGO10X60	
19.b	8	PARAF.5 X 40 CAB.CHATA PHILIPS	TORNILLO 5 X 40MM	SCREW 5 X 40MM	
7.y	3	FIXACAO DE LASTRO NR7	FIXING BALLAST	FIJACIÓN LASTRE	

RELAÇÃO DE COMPONENTES / PARTS LIST / LISTA DE COMPONENTES

CÓDIGO DO KIT: **K071995**

KIT 2

REF.	QTDE	PEÇA	PART	PIEZA	IMAGE
15.b	14	PARAF.5 X 20 CAB.CHATA PHILIPS	TORNILLO 5 X 20MM	SCREW 5 X 20MM	
19.b	12	PARAF.5 X 40 CAB.CHATA PHILIPS	TORNILLO 5 X 40MM	SCREW 5 X 40MM	

Passo Step **1** Paso

2800x1200MM
3000x1200MM
3200x1200MM

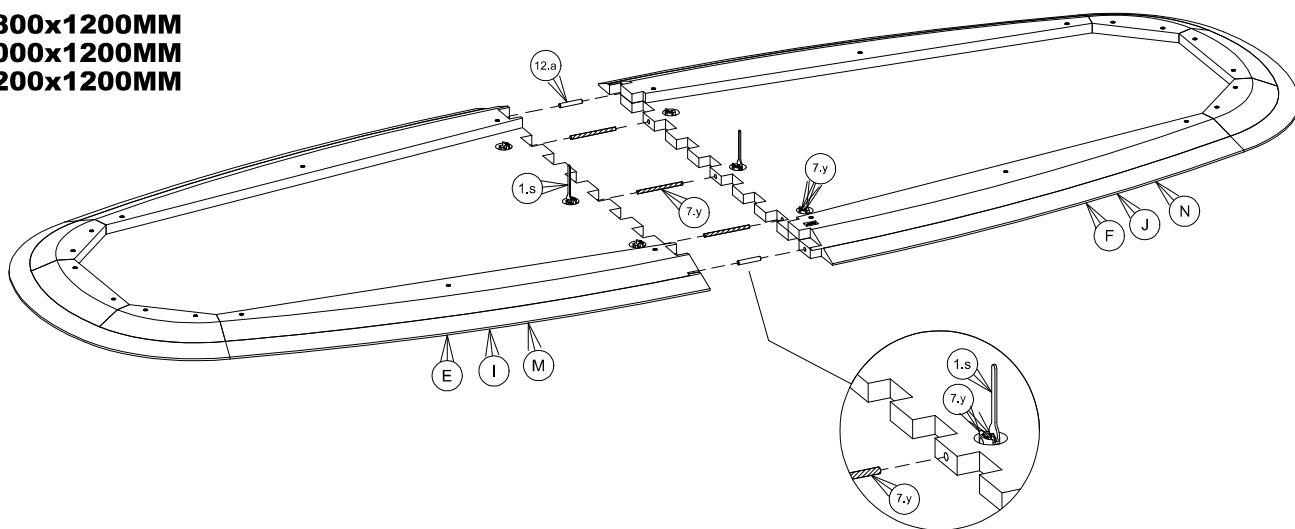

Passo Step **2** Paso

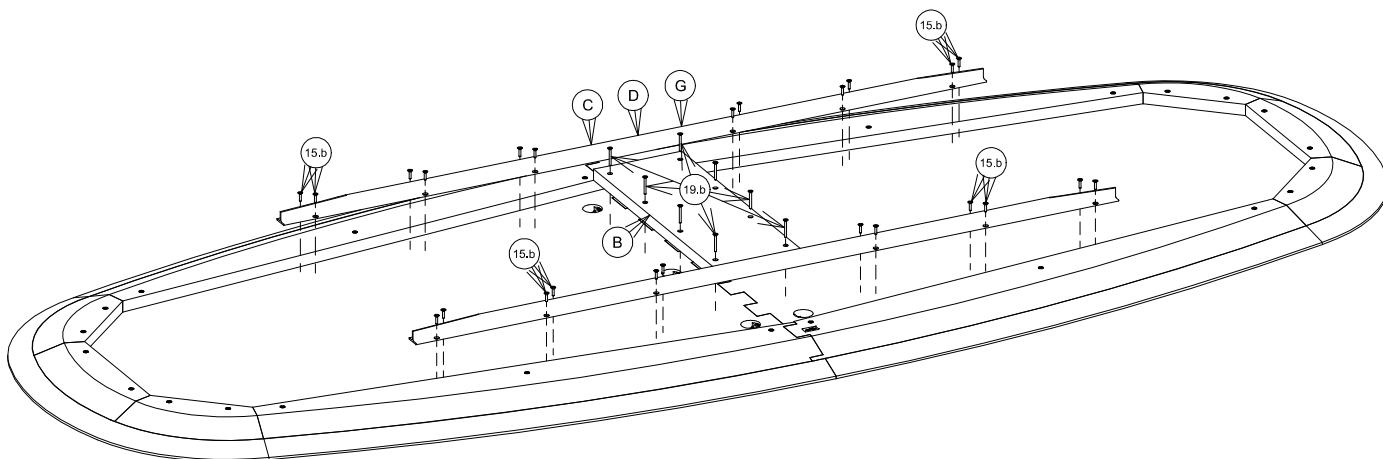

MH-9145

Passo
Step **3**
Paso

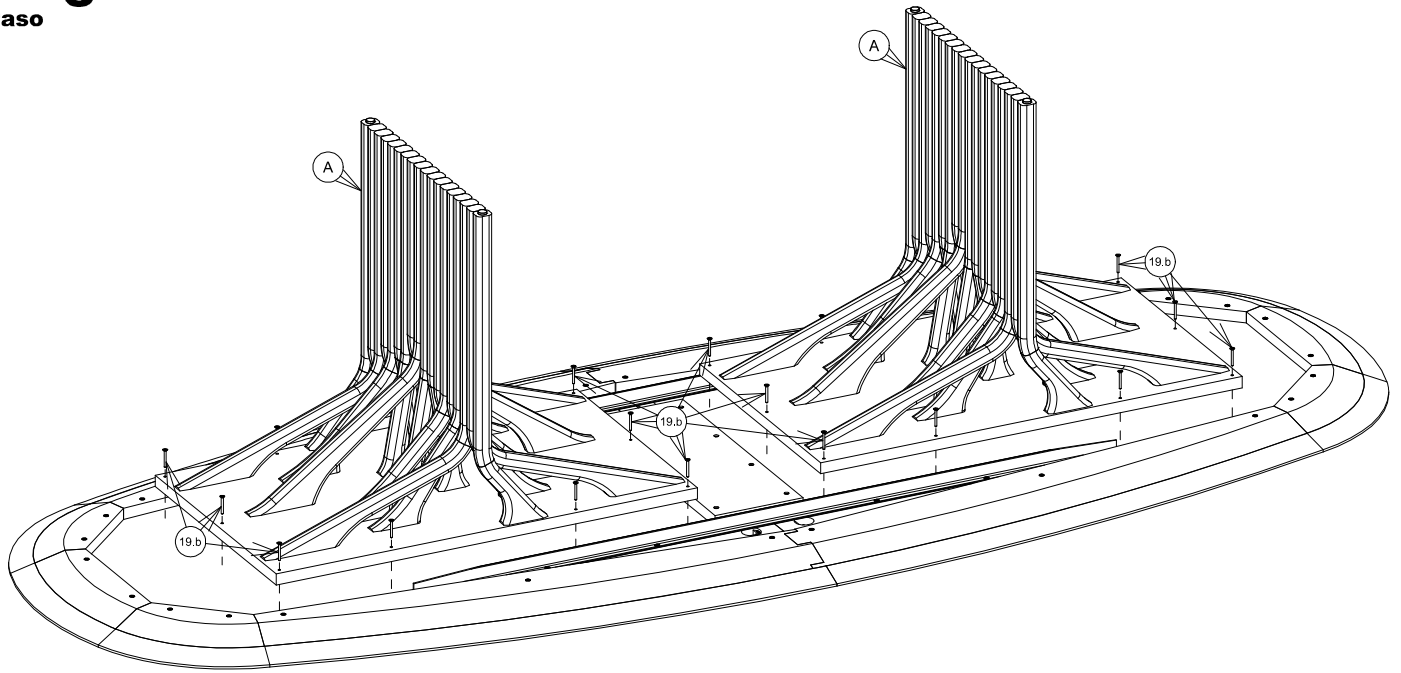

Passo
Step **4**
Paso

2800x1200MM

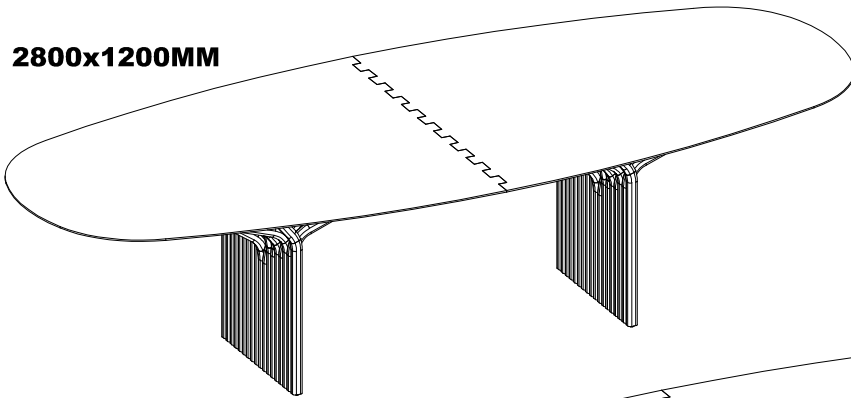

3000x1200MM

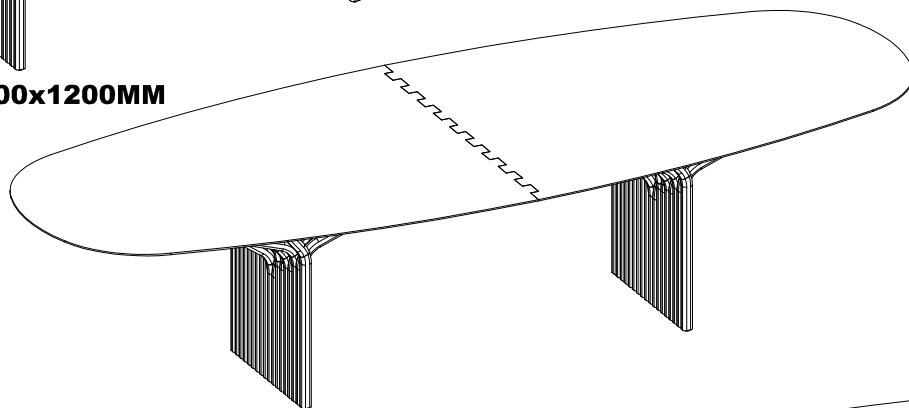

3200x1200MM

