

MH 9906 – Bed with wooden frame

List of components

VOLUME 1

1380 x 1880mm / 1580 x 1980 mm / 1930 x 2030mm

REFERENCE	PIECE	QUANTITY
A	UPHOLSTERED HEADBOARD	1

VOLUME 2

1380 x 1880mm / 1580 x 1980mm / 1930 x 2030mm

B	RIGHT SIDE	1
C	LEFT SIDE	1
D	BED FOOTBOARD	1

VOLUME 3

1380 x 1880mm

E	BED SUPPORT	1390x60x30mm	4
---	-------------	--------------	---

1580 x 1980mm

E	BED SUPPORT	1590x60x30mm	4
---	-------------	--------------	---

1930 x 2030mm

E	BED SUPPORT	1930x60x30mm	4
---	-------------	--------------	---

1380 x 1880 / 1580 x 1580mm / 1930 x 2030mm

F	WOODEN BALLAST	1
---	----------------	---

G	NAIL WITH HEAD 13X15mm	1380 - 48 Pcs
---	------------------------	---------------

1580 - 56 Pcs

1930 - 68 Pcs



KIT COMPONENTS

VOL. 3

G 

NAIL WITH HEAD 13X15mm

1380 - 48 Pcs
1580 - 56 Pcs
1930 - 68 Pcs

FITTING LIST (vol.4)

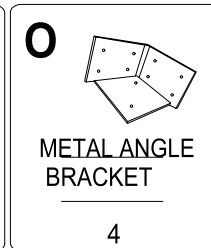
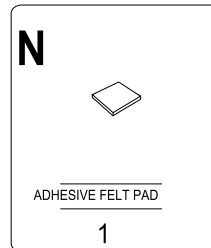
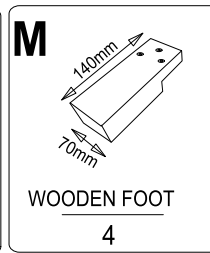
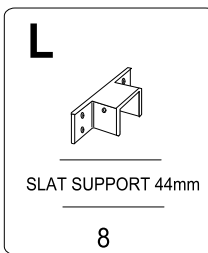
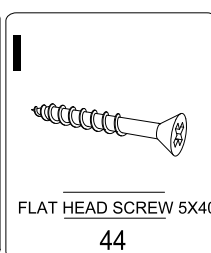
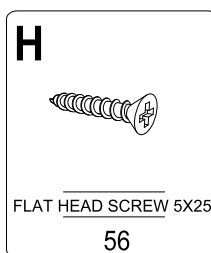

CONSUMER GUIDELINES :



Do not use chemical, abrasive or steam cleaning products. Avoid contact with sharp objects and prolonged sun exposure;



Fabric: vacuum cleaner or soft bristle brush; Feet: cloth slightly moistened with water, followed by dry cloth;



Tool required: not provided;

Screwdriver



People required for product assembly.

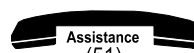

3564-8382

contato@uultis.com
www.uultis.com

* IMAGE MERELY ILLUSTRATIVE.

1380x1880 - 1580x1980 - 1930 X 2030mm

STEP 1.

Fit the hardware (O) according to the part hole (A)

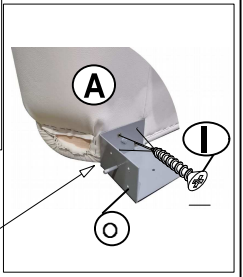
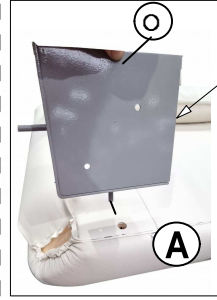

Leave aligned and secure with 4 screws (I)

STEP 2. Fit the hardware (O) according to the part hole (B,C)

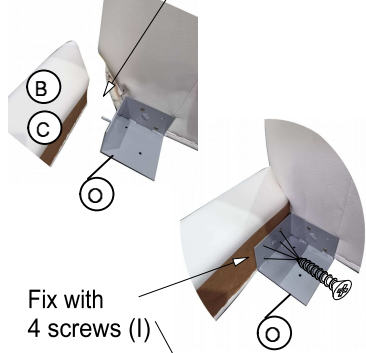

Fix with 4 screws (I)

STEP 3

Attach the foot (P) to angle bracket (O).

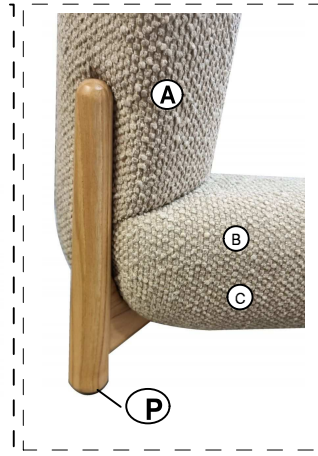
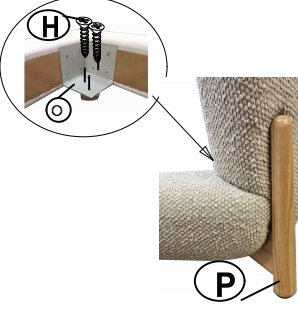

STEP 1

Screw the slat support (L) with flat head screw 5x25 (H) on the extremities of the slat support / bed support (E); Figure 1

STEP 2

Screw the middle wooden foot (M) with screws 5x40 (I) on the slat support / bed support (E); Figure 1

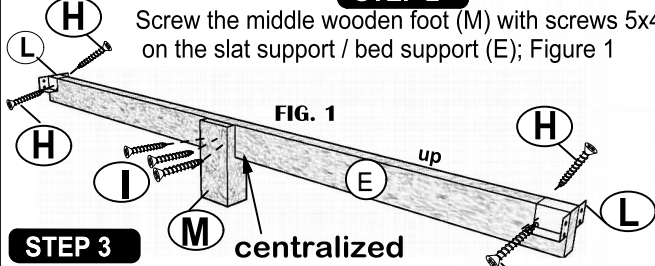

STEP 3

centralized

Attach the bed support (E) with slat support (L) with screws 5x25 (Figure 2) on the sides of the bed (B,C)

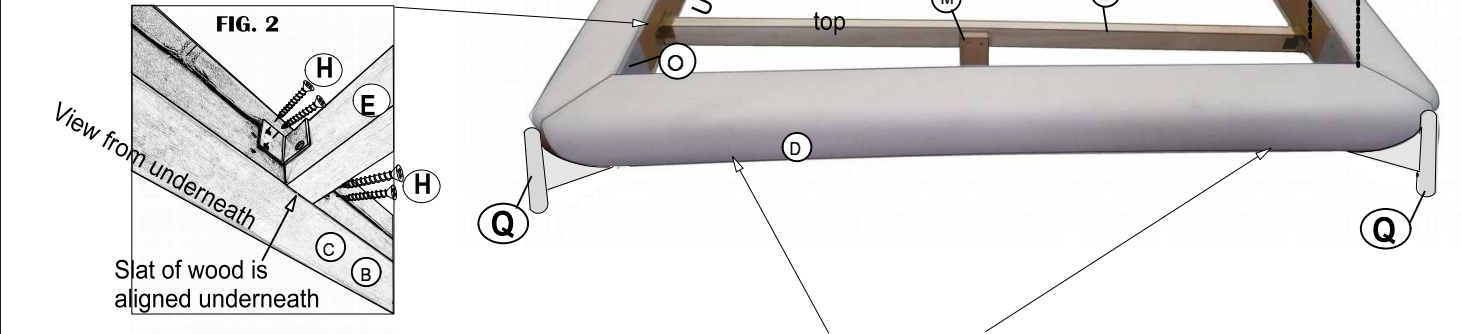
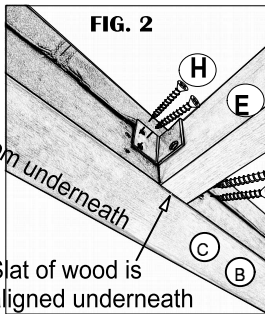

1580/1930= 1820mm
1380= 1660mm
1580/1930= 1180mm
1380= 1120mm
1580/1930= 830mm
1380= 780mm
200mm

STEP 1.

Fit the hardware (O) according to the part hole (D)

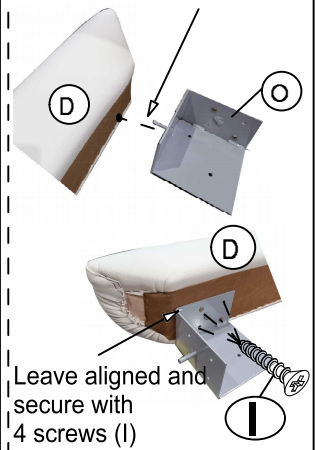

Leave aligned and secure with 4 screws (I)

STEP 2.

Fit the hardware (O) according to the part hole (B,C)

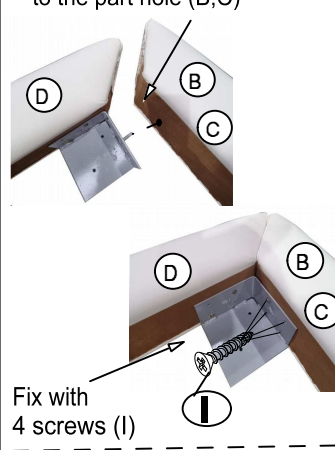

Fix with 4 screws (I)

STEP 3

Attach the foot (P) to angle bracket (O).

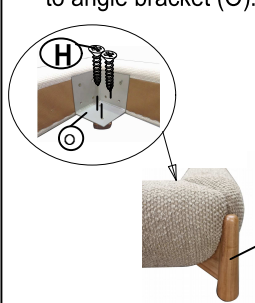

Ref.	Qty	Image
G	1380 - 48PCs 1580 - 56PCs 1930 - 68PCs	

E:
Headboard .1380 =1390 x 60 x 30mm
Headboard .1580=1590 x 60 x 30mm
Headboard .1930=1930 x 60 x 30mm

