

MH-9907 Model

Bed 1580/1930mm

VOLUME 3

1530 X 1980MM / 1930 X 2030MM

A	RIGHT SIDE BED	1
B	LEFT SIDE BED	1
C	BED FOOTBOARD	1
D	WOODEN FEET 180 X 70 X 45MM	6

VOLUME 4

1530 X 1980MM

E	BED SUPPORT	4
---	-------------	---

1930 X 2030MM

E	BED SUPPORT	4
---	-------------	---

1530 X 1980MM / 1930 X 2030MM

F	WOODEN BALLAST	2
G	NAIL HEAD 13X15	1530- 56PC 1930- 68PC

COMPONENTES DOS KIT'S

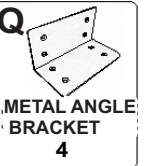
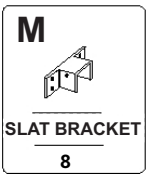
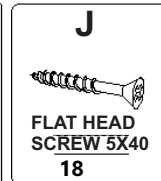
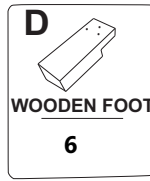

1º Passo: Align the ends and secure with 8 5x25 screws

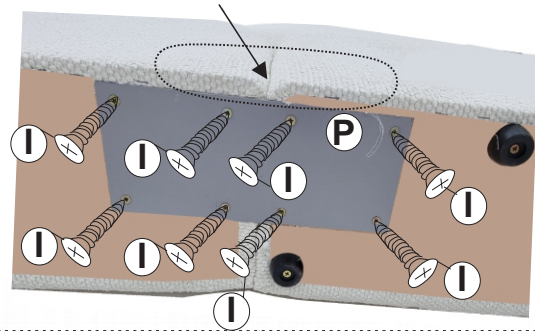

Volume 01
1 Iron plate +
8 5x25 screws

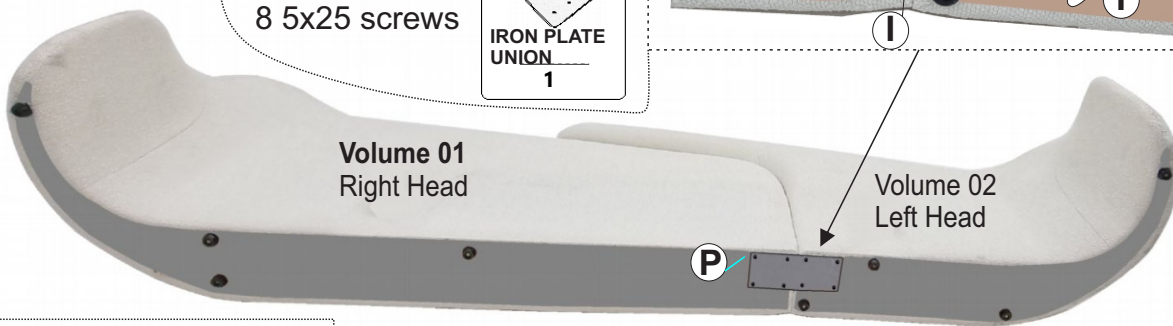
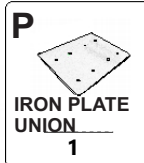

2nd Step

Screw foot (D) with 3 5x40 screws (J) to the bed crossbar (E) Fig.1/2
*2 Crossbar bracket (E) with 2 feet according to Fig.1
*2 Crossbar bracket (E) with 1 foot according to Fig.2

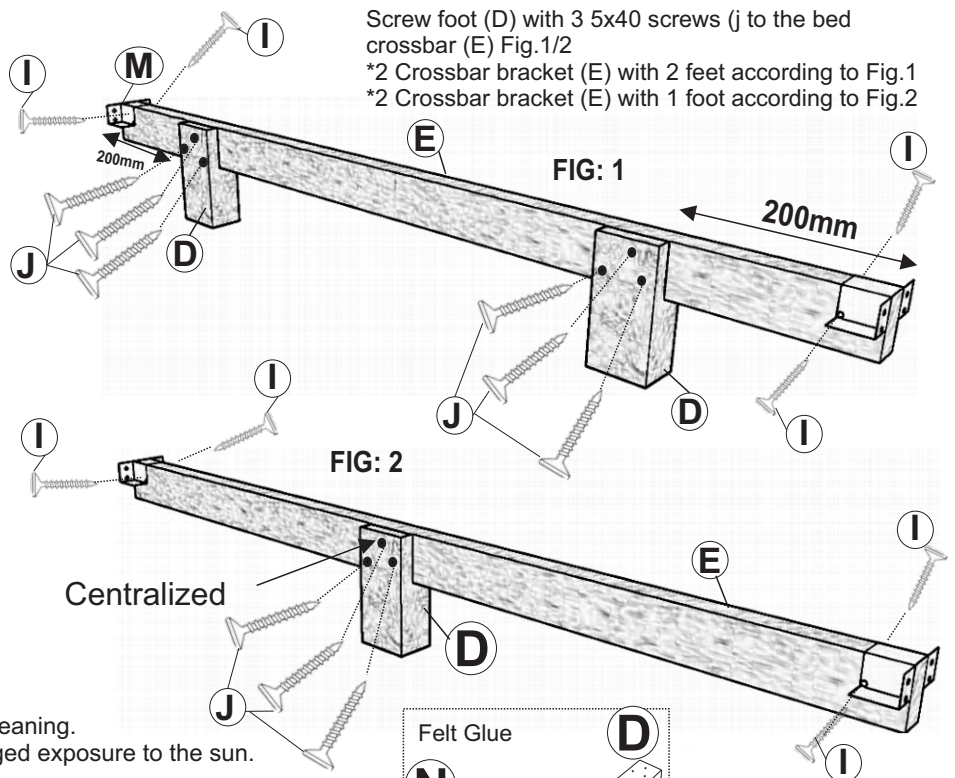

3rd Step:

Screw metal bracket (M) with 5x25 screw (I) at the ends of the bracket/crossbar (E) Fig.1/2

CONSUMER GUIDELINES:

⚠ Do not use chemicals, abrasives or steam cleaning.
Avoid contact with sharp objects and prolonged exposure to the sun.

🧹 Fabric: vacuum cleaner brush with soft bristles;
Feet: cloth slightly dampened with water, second of dry cloth.

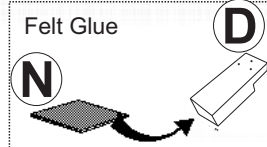

4rd Step:

Fixing Hardware (Q) with 8 Screws 5x25 as shown in fig: 3

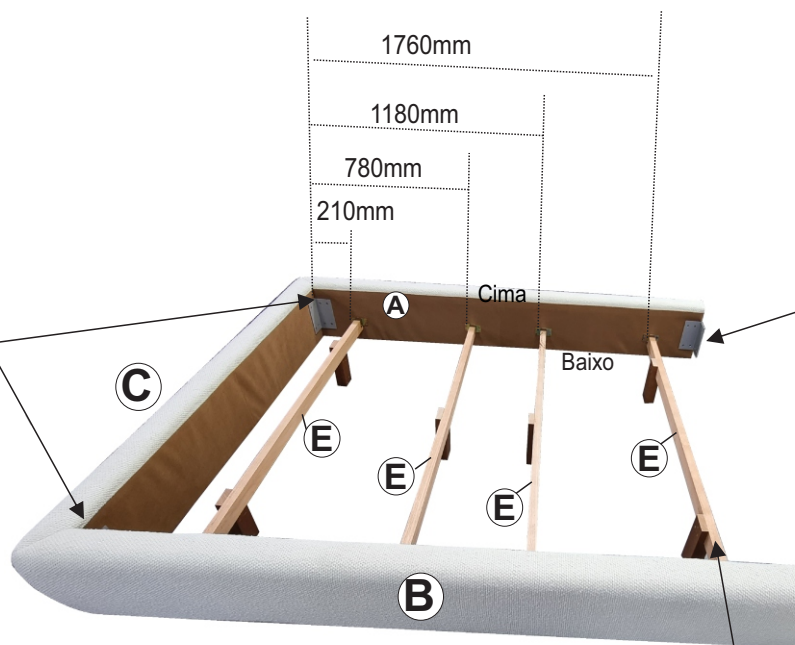
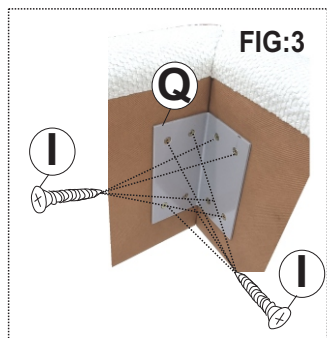

4rd Step:

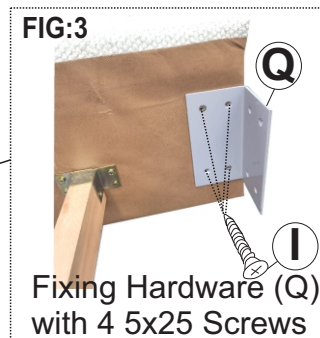

Fixing Hardware (Q) with 4 5x25 Screws

6rd Step:

Fix Hardware (Q) with 4 5x25 Screws On the headboard as shown in fig:5

1° Center the bed at the headboard
2° Fix the hardware (Q)

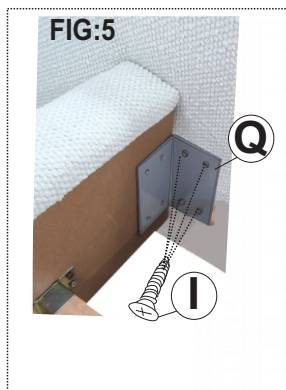

5rd Step:

Fix Hardware (M) with 4 Screws 5x25 In (A) - (B) as per fig:4

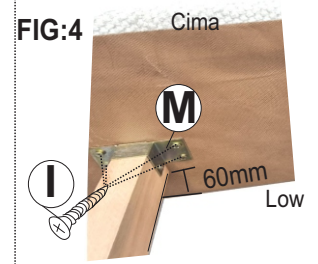

7rd Step:

*Leave drawstring on the underside ballast (Q) of the wood
*Fasten with nail (H) in all the wood of the ballast

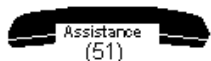
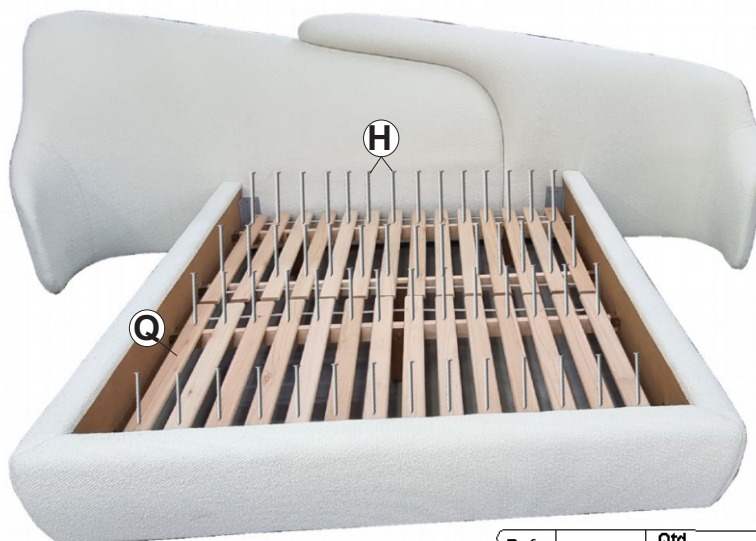

3564-8382
www.fofo.com
www.fofo.com

* IMAGE MERELY ILLUSTRATIVE.

Ref.	Qtd	
(H)	1580- 56PÇ 1930- 68PÇ	